

Petunjuk pembuatan aksesoris cable tray wiremesh

* Elbow : cara 1

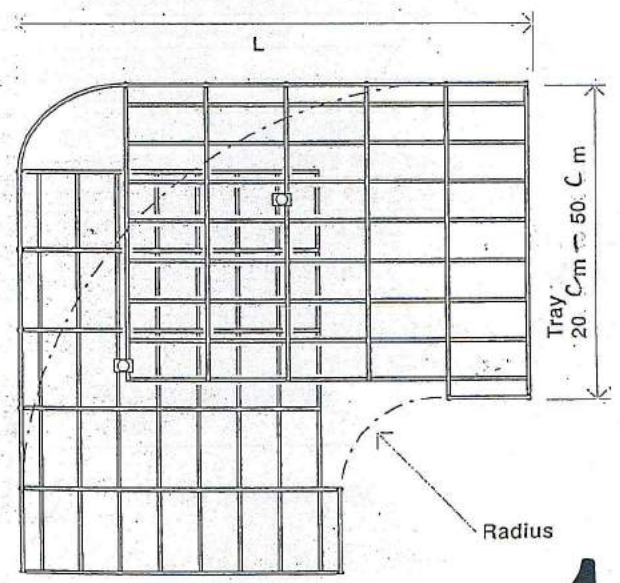

* Elbow : Cara 2

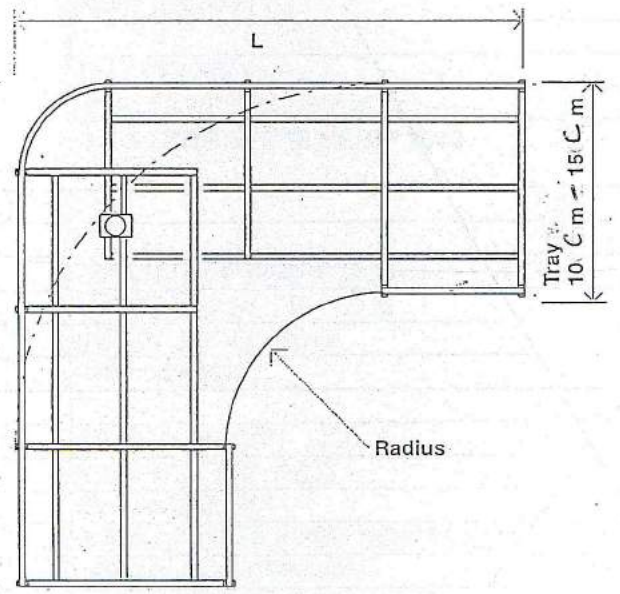
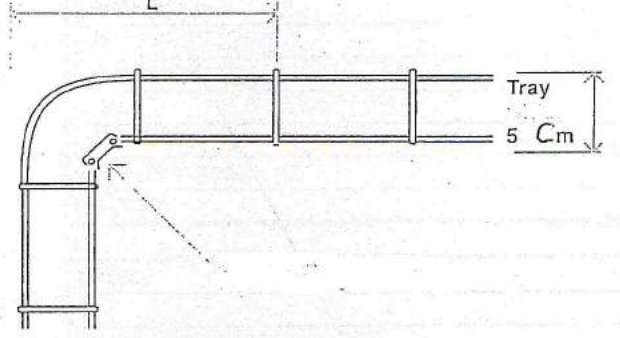
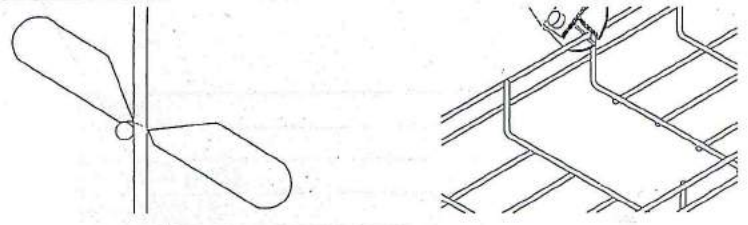
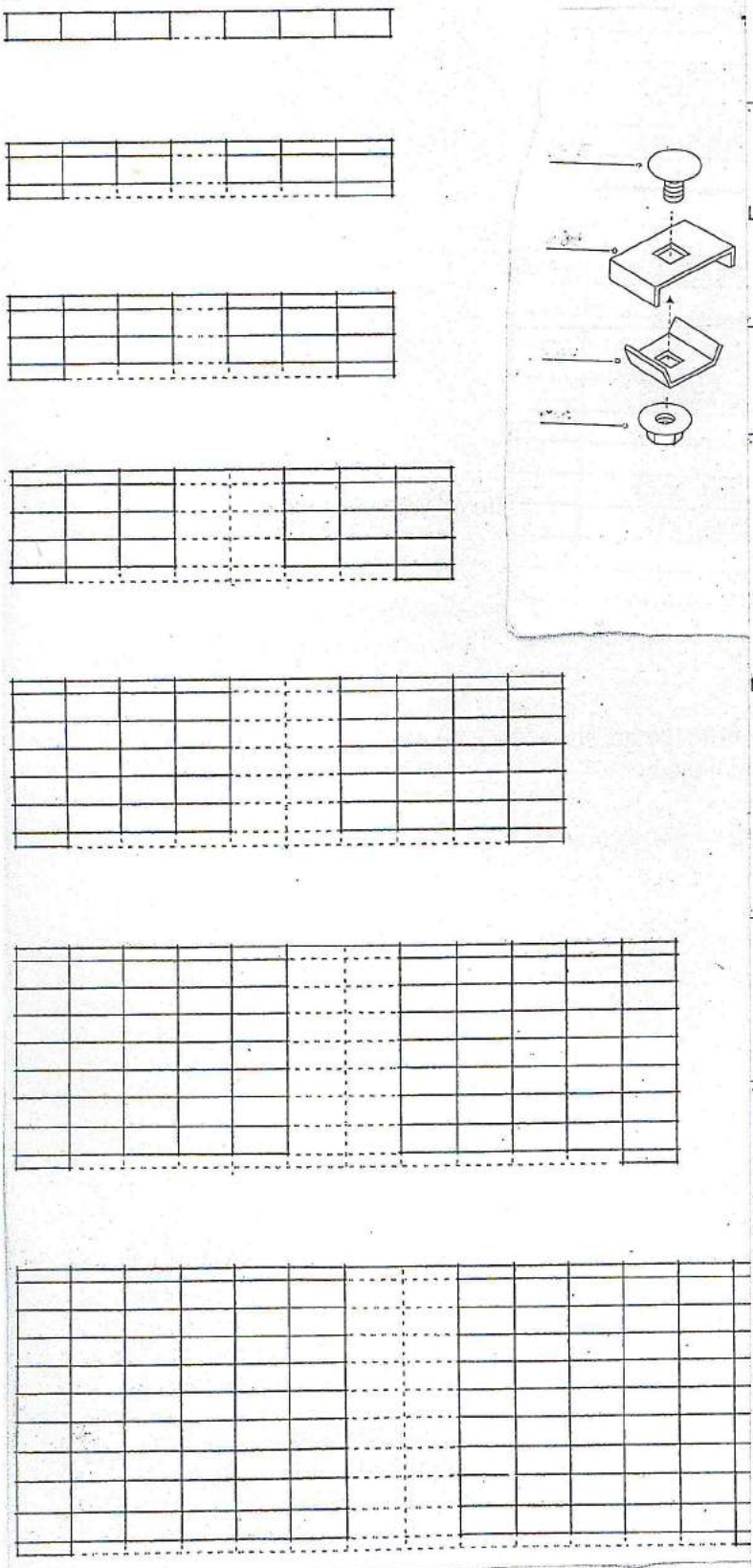
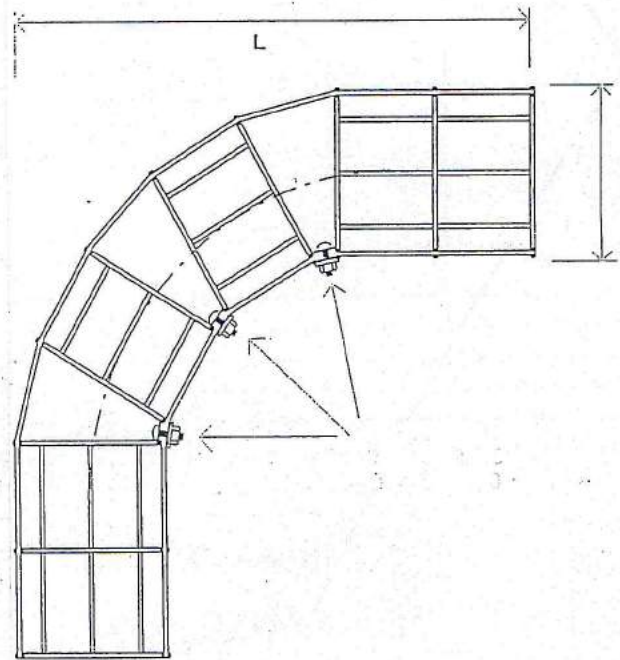
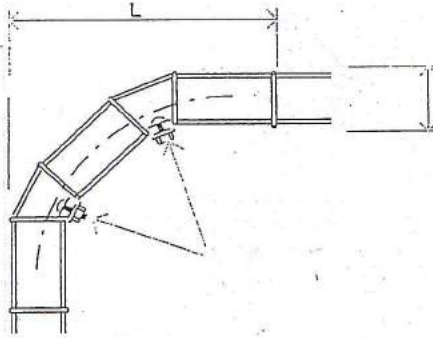
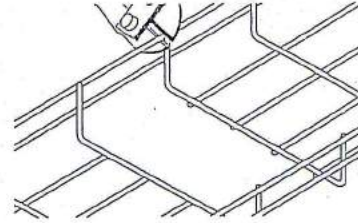
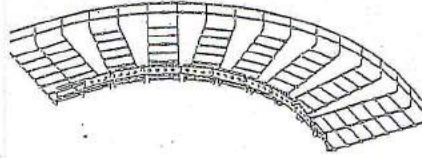
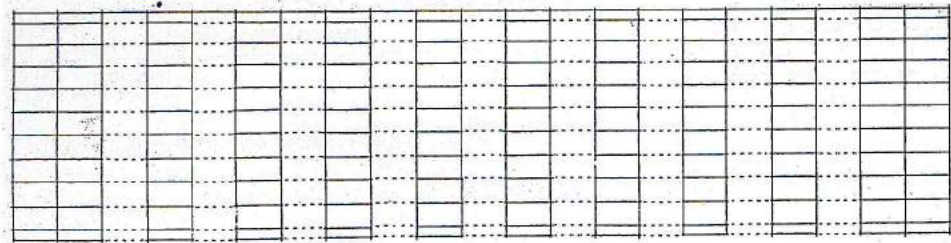
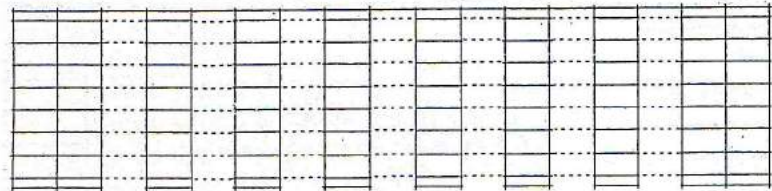
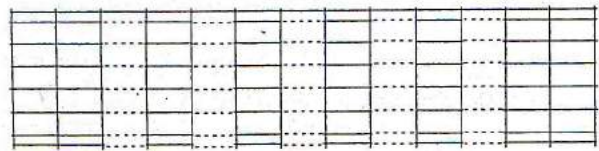
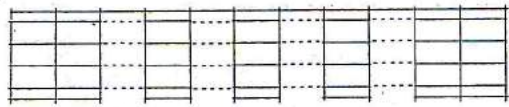
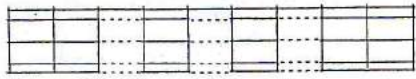
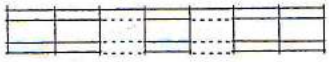
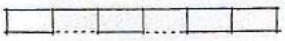

* Cross (cabang 4)

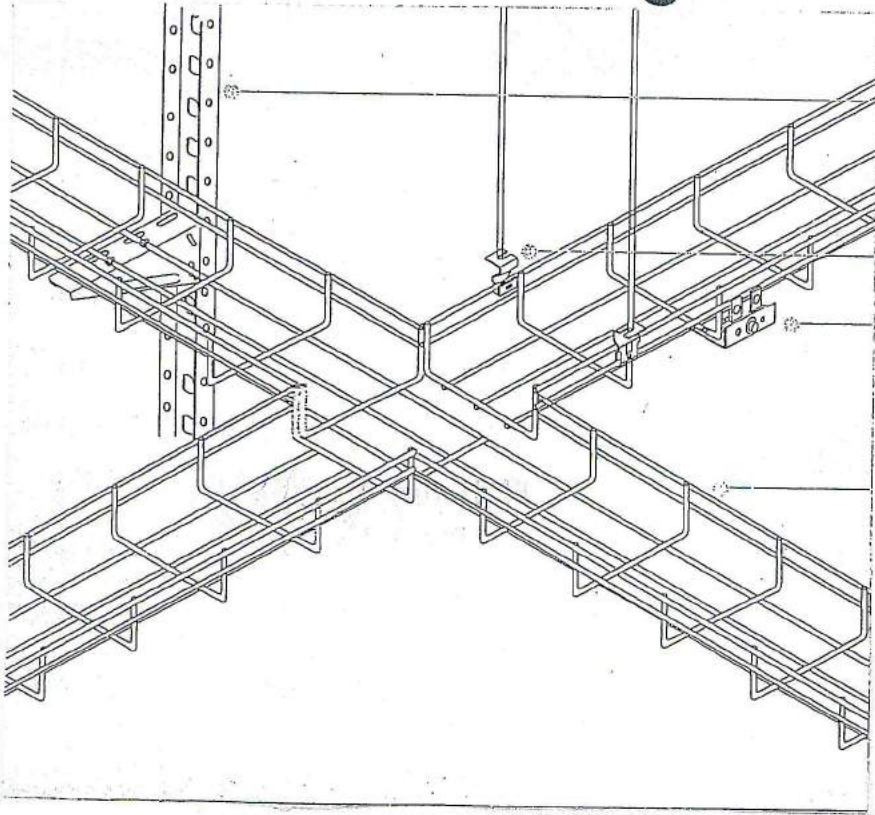

* reduser

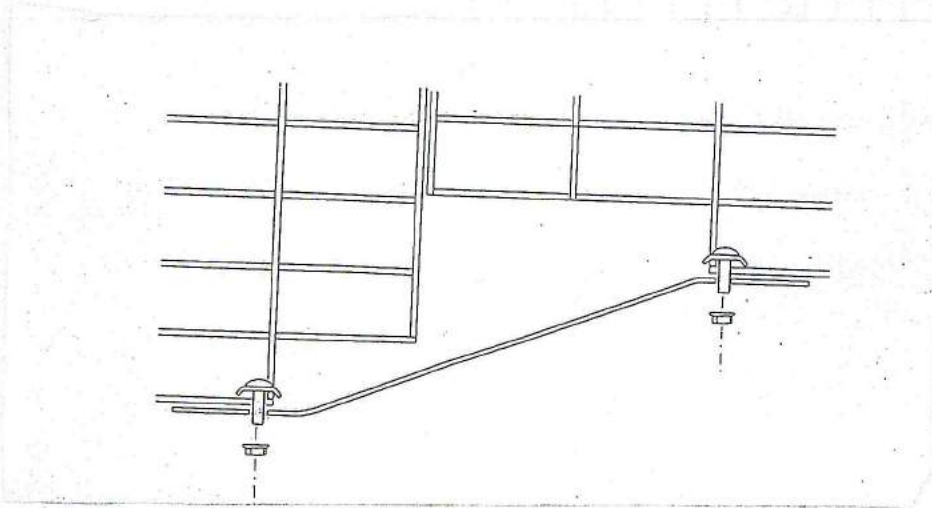

* Tee (cabang 3) : Cara 1

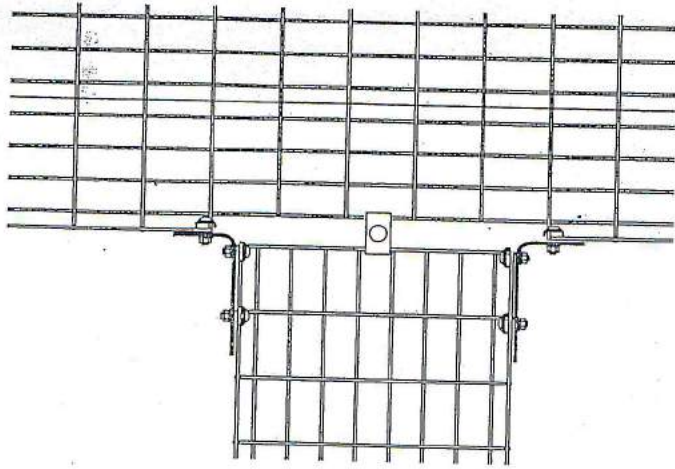

* Tee : cara 2

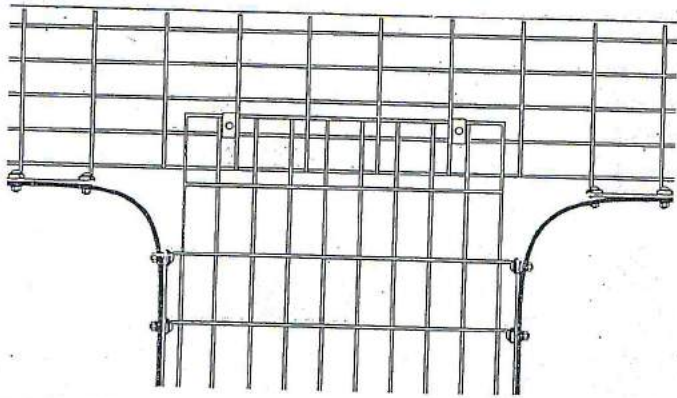

* Z - riser

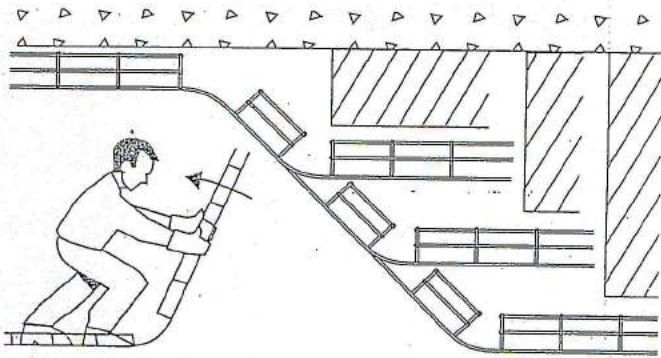

* IR - inside riser

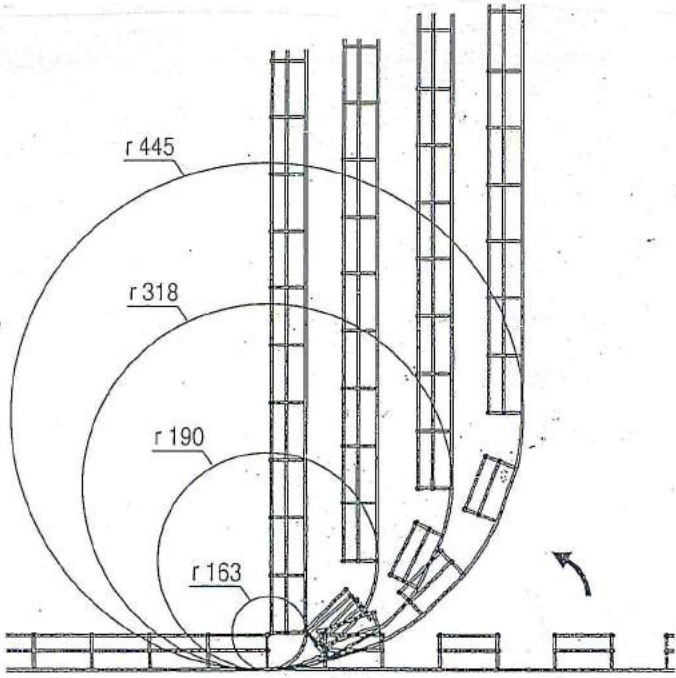

* OR - outside riser

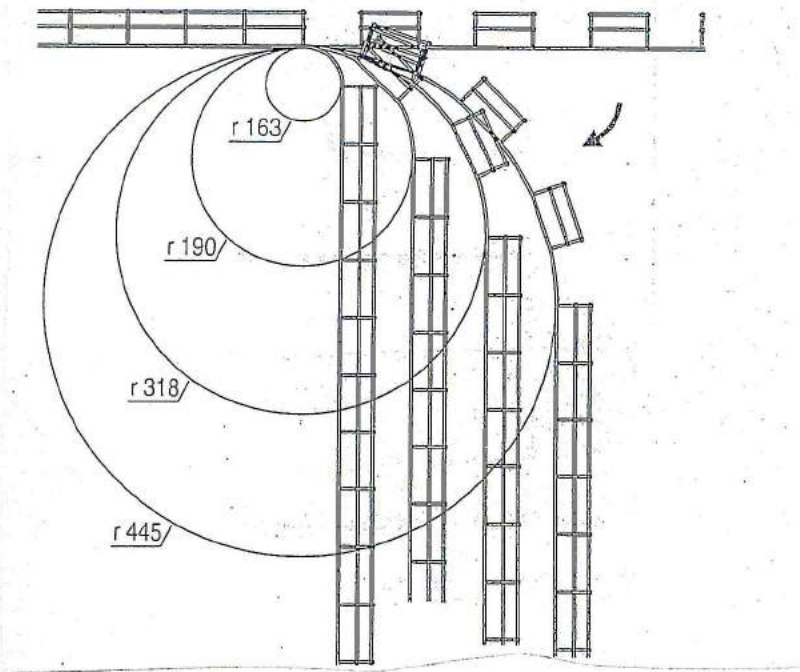

* Joiner

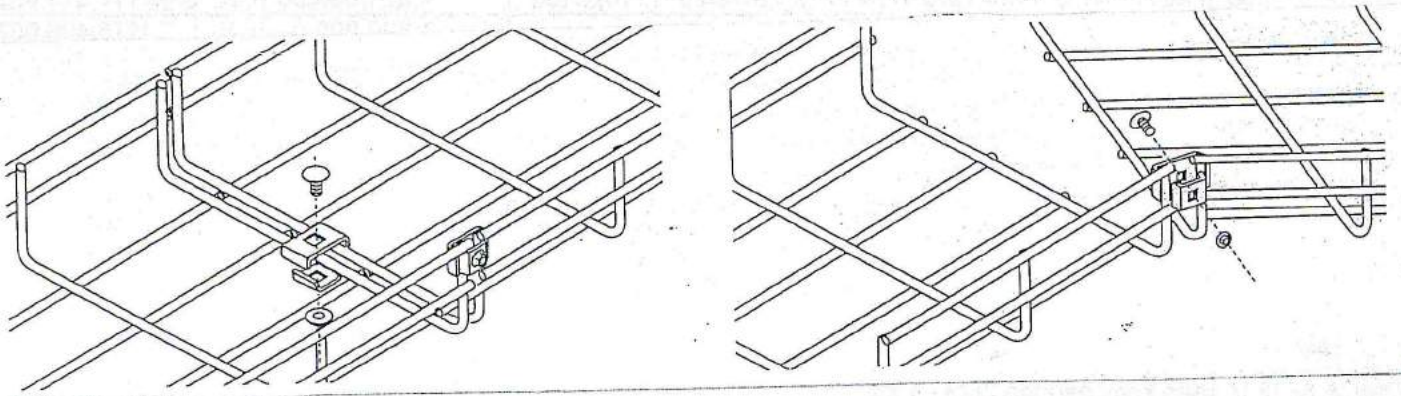

* Hanger

